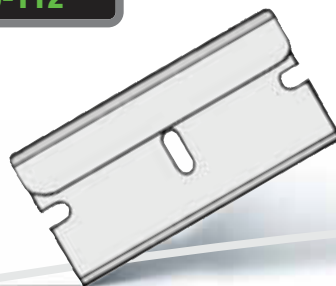

## 30-112

**Single Edge Razor Blades**

- ▼ #9 gauge (.009")
- ▼ Most popular scraper blade
- ▼ Used in automotive, glazing, cleaning etc.

CODE	DESCRIPTION	BOX QTY	CTN QTY
30-112	Box of 100 Made in USA	1	50
05-491	Box of 100 Made in USA	1	50
SEB-100VP	Clamshell of 100 Made in USA	1	50
SEB-10	Card of 10 Made in USA	10	500
30-101	Pack of 5 Made in USA	20*	1000
291-1	Card of 5 Made in USA	20*	1000
35005	Card of 5 Made in PROC	20*	200

\* Box quantities only

L 39mm W 19.6mm T 0.24mm

## 30-117

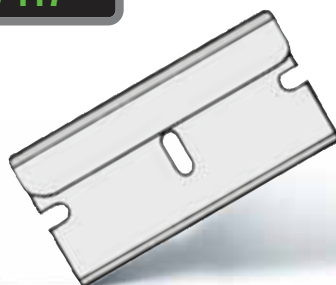
**Single Edge Razor Blades – Heavy Duty**

- ▼ Made in USA. #12 gauge (.012")

CODE	DESCRIPTION	BOX QTY	CTN QTY
30-117	Box of 100 Made in USA	1	50

L 39mm W 19.6mm T 0.3mm

## 30-327

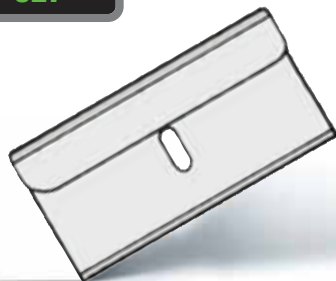
**Single Edge Razor Blades – Heavy Duty**

- ▼ No notch #12 gauge (.012")
- ▼ Suitable for picture framing
- ▼ Made in USA

CODE	DESCRIPTION	BOX QTY	CTN QTY
30-327	Box of 100 Made in USA	1	50

L 39mm W 19.6mm T 0.3mm

**911****Standard Duty Trimming Knife Blade – 911**

▼ Made in Sheffield - UK

CODE	DESCRIPTION	BOX QTY	CTN QTY
911-2	Box of 100	1	125
911-2D	Dispenser of 100	1	50
911-3	Pack of 5	20*	2000
911-4D	Dispenser of 10	10*	–
911-1	Card of 5	20*	–
* Box quantities only			
L 50mm W 18.8mm T 0.43mm			

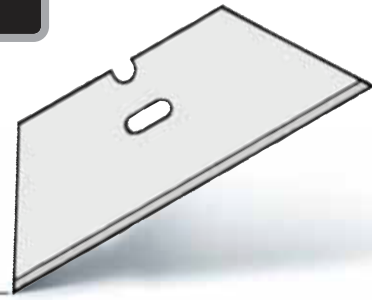
**941****Trimmer Blade 941**

▼ Made in Sheffield - UK

▼ Chisel bevel suits carpet trimmers

CODE	DESCRIPTION	BOX QTY	CTN QTY
941-2	Box of 100	1	125
941-2D	Dispenser of 100	1	50
941-3	Pack of 5	20*	2000
941-4D	Dispenser of 10	10*	–
* Box quantities only			
L 54.5mm W 18.8mm T 0.47mm			

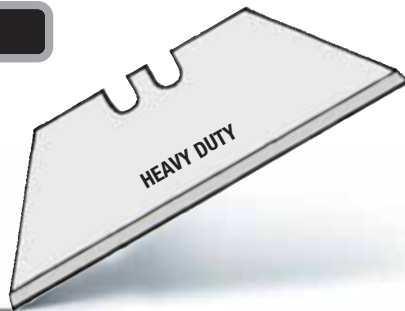
**26100****Heavy Duty Trimming Knife Blade – PROC**

CODE	DESCRIPTION	BOX QTY	CTN QTY
26100	Dispenser of 100 Carded	1	30
26010	Dispenser of 10 Carded	10	300
26005	Card of 5	20	500
L 60mm W 18.8mm T 0.63mm			

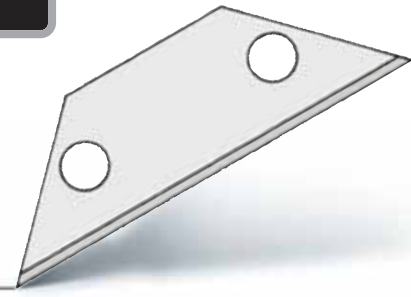
**915****2 Hole Trimmer Blade – 915**

▼ Made in Sheffield - UK

CODE	DESCRIPTION	BOX QTY	CTN QTY
915-3	Pack of 5	20*	–
915-4D	Dispenser of 10	10*	–
* Box quantities only			
L 60mm W 18.8mm T 0.43mm			

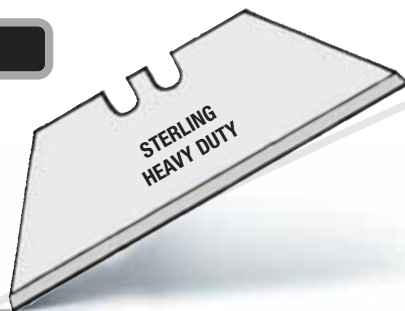
**921****Heavy Duty Trimming Knife Blade – 921**

▼ Made in Sheffield - UK

▼ Most popular universal trimming blade

CODE	DESCRIPTION	BOX QTY	CTN QTY
921-2	Box of 100	1	125
921-2D	Dispenser of 100	1	50
10-153	Box of 100 - Made in USA	1	30
921-3	Pack of 5	20*	2000
921-4D	Dispenser of 10	10*	–
921-1	Card of 5	20*	–
921-TD	Tungsten – Dispenser of 100	1	–
* Box quantities only			
L 60mm W 18.8mm T 0.63mm			



**03-018**

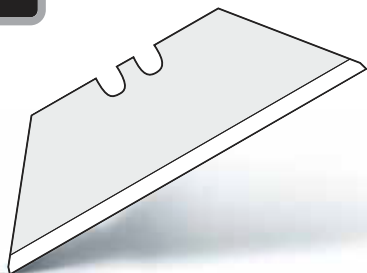

**Extra Heavy Duty Trimming Knife Blade**

- ▼ Extra thick (0.9mm) Stainless Steel
- ▼ Made in USA

CODE	DESCRIPTION	BOX QTY	CTN QTY
03-018	Box of 90	1	30

L 60mm W 18.8mm T 0.90mm

**922**

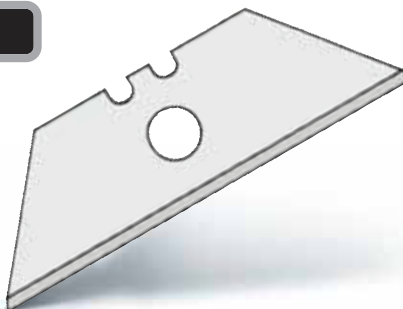

**Heavy Duty Trimming Knife Blade – 922**

- ▼ With centre hole

CODE	DESCRIPTION	BOX QTY	CTN QTY
922-3	Pack of 5 Made in Sheffield UK	20*	2000

\* Box quantities only

L 60mm W 18.8mm T 0.63mm

**924**

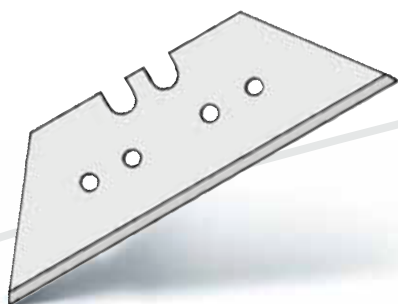

**Heavy Duty Trimming Knife Blade – 924**

- ▼ With four holes
- ▼ Made in Sheffield - UK

CODE	DESCRIPTION	BOX QTY	CTN QTY
924-3	Pack of 5	20*	2000
924-4D	Dispenser of 10	10*	-

\* Box quantities only

L 60mm W 18.8mm T 0.63mm

**9210**

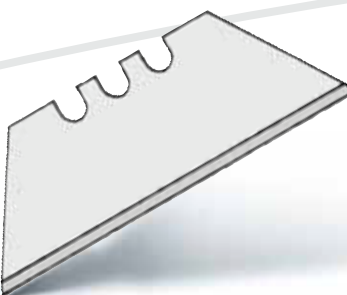

**Heavy Duty Trimming Knife Blade – 9210**

- ▼ With three notches
- ▼ Made in Sheffield - UK

CODE	DESCRIPTION	BOX QTY	CTN QTY
9210-3	Pack of 5	20*	2000

\* Box quantities only

L 52.6mm W 18.8mm T 0.63mm

**926**

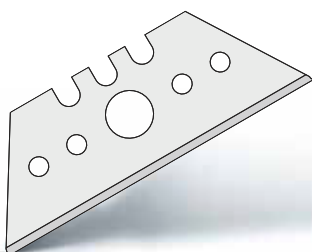

**Heavy Duty Trimming Knife Blade – 926**

- ▼ Multifit - 3 notches, 4 holes and centre hole
- ▼ Made in Sheffield - UK

CODE	DESCRIPTION	BOX QTY	CTN QTY
926-3	Pack of 5	20*	2000

\* Box quantities only

L 52.6mm W 18.8mm T 0.63mm

**412B**

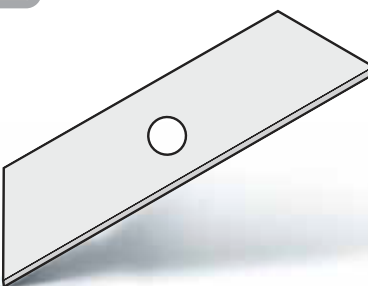

**Sideslide Knife Blade**

- ▼ Suits 412 sideslide knife. See pg. 23

CODE	DESCRIPTION	BOX QTY	CTN QTY
412B	Tube of 10	20	-

L 71.8mm W 17.4mm T 0.60mm

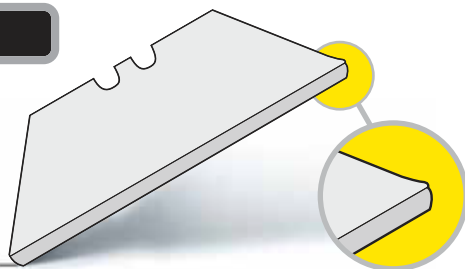
**928****Heavy Duty Trimming Knife Blade – Safety Tip**

- ▼ Rounded on sharp points for safety
- ▼ Prevents damage to carton contents
- ▼ Made in Sheffield - UK

CODE	DESCRIPTION	BOX QTY	CTN QTY
928-3	Pack of 5	20*	600
928-4D	Dispenser of 10	10*	-

\* Box quantities only

L 50mm W 18.8mm T 0.65mm

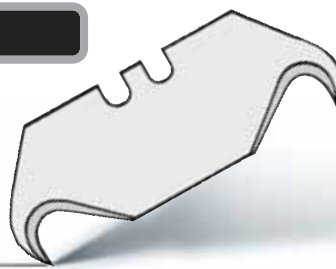
**961****Hooked Trimming Knife Blade – 961**

- ▼ Standard depth hook
- ▼ Made in Sheffield - UK

CODE	DESCRIPTION	BOX QTY	CTN QTY
961-2	Box of 100	1	125
961-2D	Dispenser of 100	1	50
961-3	Pack of 5	20*	2000
961-4D	Dispenser of 10	10*	-
961-1	Card of 5	20*	-

\* Box quantities only

L 50mm W 18.8mm T 0.63mm

**963****Hooked Trimming Knife Blade – 963**

- ▼ Standard depth hook with centre hole
- ▼ Made in Germany or Sheffield

CODE	DESCRIPTION	BOX QTY	CTN QTY
963-3	Pack of 5 Made in Sheffield	20*	2000
963-4D	Dispenser of 10 Made in Sheffield	10*	-
104-063	Dispenser of 10 Made in Germany	10*	100

\* Box quantities only

L 50mm W 18.8mm T 0.63mm

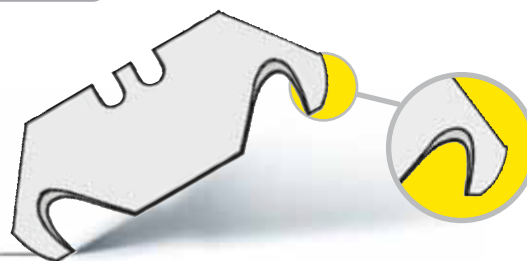
**968****Hooked Trimming Knife Blade – 968**

- ▼ Hook with blunt points for safety
- ▼ Made in Sheffield - UK

CODE	DESCRIPTION	BOX QTY	CTN QTY
968-3	Pack of 5	20*	2000

\* Box quantities only

L 50mm W 18.8mm T 0.63mm

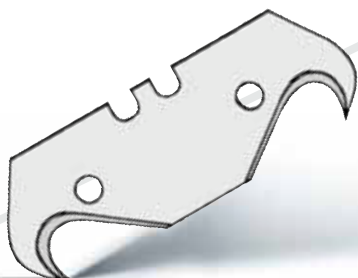
**964****Hooked Trimming Knife Blade – 964**

- ▼ Medium depth hook
- ▼ Made in Sheffield - UK

CODE	DESCRIPTION	BOX QTY	CTN QTY
964-3	Pack of 5	20*	2000
964-4D	Dispenser of 10	10*	-

\* Box quantities only

L 50mm W 18.8mm T 0.63mm

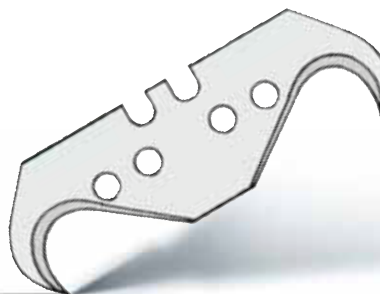
**962****Deep Hooked Trimming Knife Blade**

- ▼ Deep hook
- ▼ Made in Germany or Sheffield

CODE	DESCRIPTION	BOX QTY	CTN QTY
962-3	Pack of 5 Made in Sheffield	20*	2000
962-4D	Dispenser of 10 Made in Sheffield	10*	100
105-063	Dispenser of 10 Made in Germany	10*	100

\* Box quantities only

L 56mm W 18.8mm T 0.65mm

**9600**

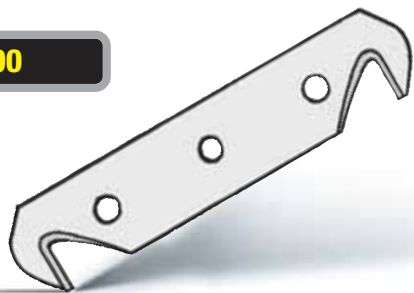

**Special Hook Blade**

- ▼ Suits Armstrong #S66 vinyl wall trimmer
- ▼ Made in USA

CODE	DESCRIPTION	BOX QTY	CTN QTY
9600-3	Pack of 5	1	-

L 60mm W 12.7mm T 0.65mm

**991**

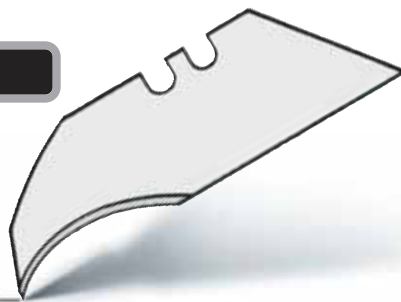

**Standard Concave Trimming Knife Blade - 991**

- ▼ Made in Sheffield - UK

CODE	DESCRIPTION	BOX QTY	CTN QTY
991-2	Box of 100	1	125
991-2D	Dispenser of 100	1	50
991-3	Pack of 5	20*	2000
991-4D	Dispenser of 10	10*	-
991-1	Card of 5	20*	-
991-TD	Tungsten - Dispenser of 100	1	-

\* Box quantities only

L 58.7mm W 18.8mm T 0.63mm

**992**

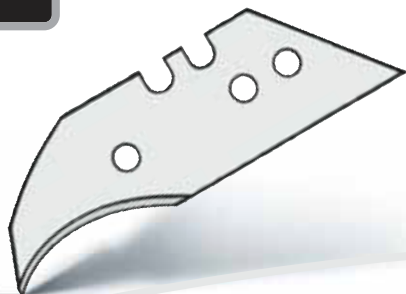

**Concave Trimming Knife Blade - 992**

- ▼ Three holes
- ▼ Made in Sheffield - UK

CODE	DESCRIPTION	BOX QTY	CTN QTY
992-3	Pack of 5	20*	2000
992-4D	Dispenser of 10	10*	-

\* Box quantities only

L 58.7mm W 18.8mm T 0.63mm

**160-063**

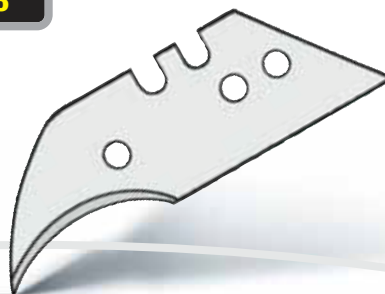

**Concave Trimming Knife Blade - German**

- ▼ Long beak with three holes
- ▼ Made in Germany

CODE	DESCRIPTION	BOX QTY	CTN QTY
160-063	Dispenser of 10	10*	100

\* Box quantities only

L 59mm W 18.8mm T 0.63mm

**981**

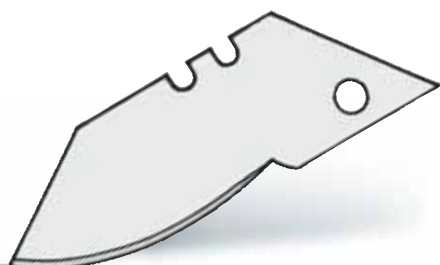

**Convex Trimming Knife Blade - 981**

- ▼ Made in Sheffield - UK

CODE	DESCRIPTION	BOX QTY	CTN QTY
981-2	Box of 100	1	-

L 60mm W 18.8mm T 0.63mm

**03-153**

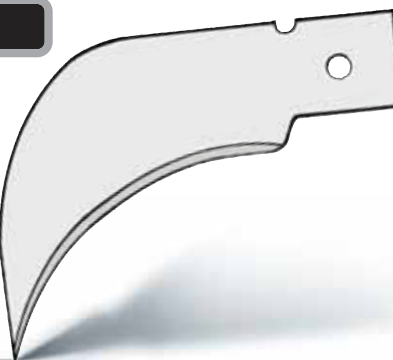

**Linoleum Blade**

- ▼ Made in USA

CODE	DESCRIPTION	BOX QTY	CTN QTY
03-153	Card of 1	1	10

L 78mm W 18.8/59mm T 0.80mm



**206-1****22mm Extra Large Snap Off Blade – 206**

▼ 7 point, 22mm wide, 0.7mm thick

▼ Suits 770-1 Cutter. See pg. 12

CODE	DESCRIPTION	BOX QTY	CTN QTY
206-1	Card of 10	1	10
L 111mm W 22mm T 0.7mm			

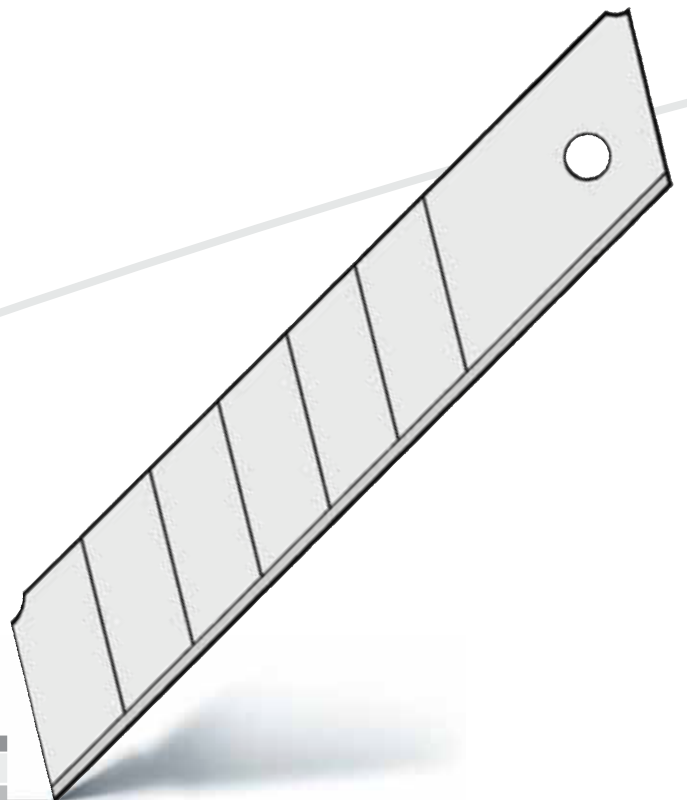

**209-4**

**25mm Extra Large Non Segmented Blade – 209**

- ▼ Non snap off 25mm wide
- ▼ Suits 700-1 and 701-1 Cutters. See pg. 11

CODE	DESCRIPTION	BOX QTY	CTN QTY
209-4	Tube of 10 Made in Taiwan	1	10
209-2	Tube of 25 Made in Sheffield	1	-
		L 139mm	W 25mm T 0.7mm

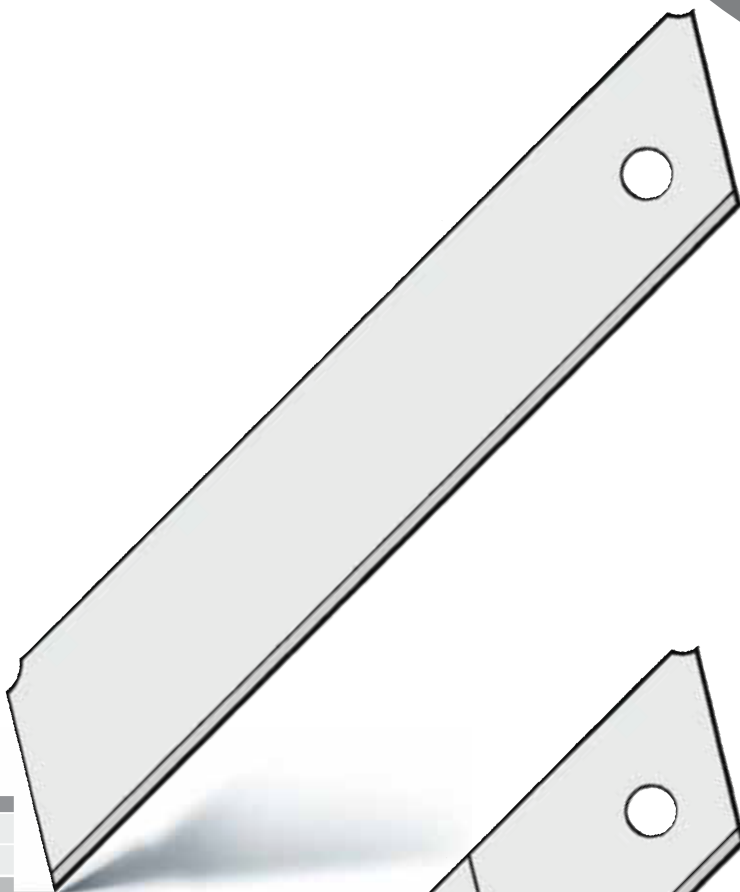

**207-1**

**25mm Extra Large Snap Off Blade – 207**

- ▼ 7 point, 25mm wide, 0.7mm thick
- ▼ Suits 700-1 and 701-1 Cutters. See pg. 11

CODE	DESCRIPTION	BOX QTY	CTN QTY
207-1	Card of 10 Made in Taiwan	1	10
207-2	Tube of 25 Made in Sheffield	1	-
		L 139mm	W 25mm T 0.7mm

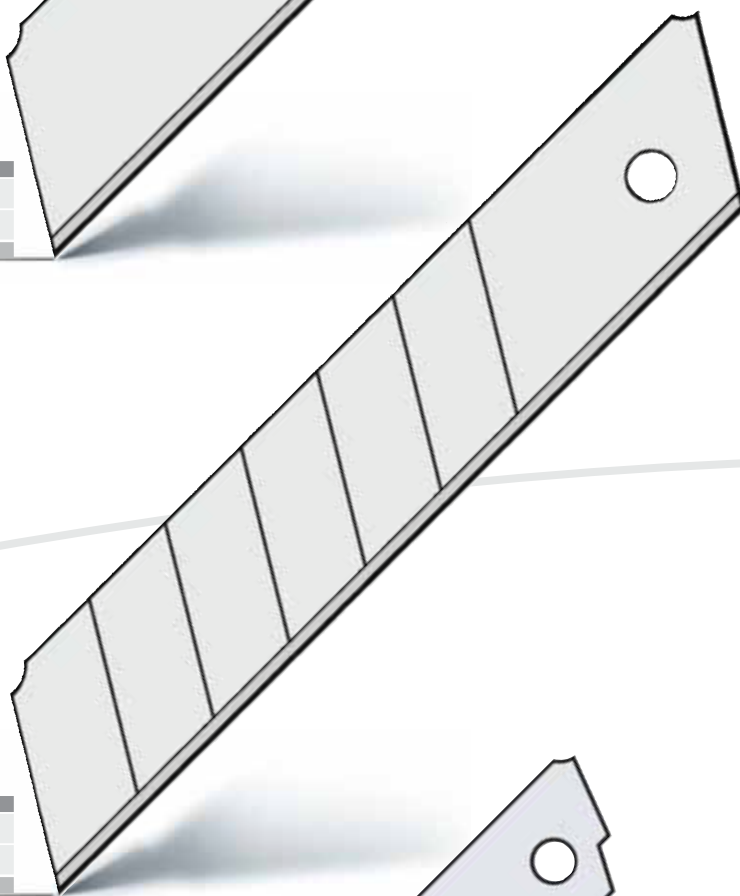

**215-4**

**18mm Hooked Snap Blade**

- ▼ 4 point, 18mm wide, 0.5mm thick
- ▼ Made in Germany
- ▼ Suits all Large 18mm Snap Cutters. See pg. 12-17

CODE	DESCRIPTION	BOX QTY	CTN QTY
215-4	Tube of 10	10	-
		W 18mm	T 0.5mm

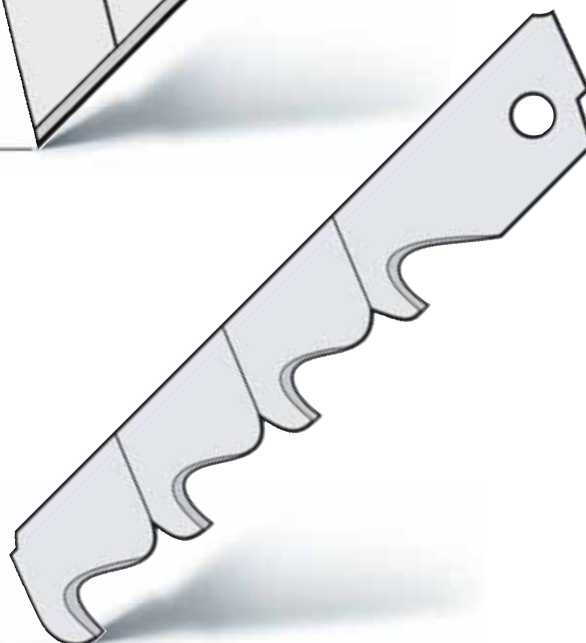

**201****Large Snap Off Blade – 201**

- ▼ 8 point 18mm wide
- ▼ Made in Sheffield - UK
- ▼ Suits all Large 18mm Snap Cutters. See pg. 12-17

CODE	DESCRIPTION	BOX QTY	CTN QTY
201-2	Tube of 50 - Sheffield	1	100
201-4	Tube of 10 - Sheffield	10*	500
201-1	Card of 10 - Sheffield	10*	-
* Box quantities only			
L 110mm W 18mm T 0.5mm			

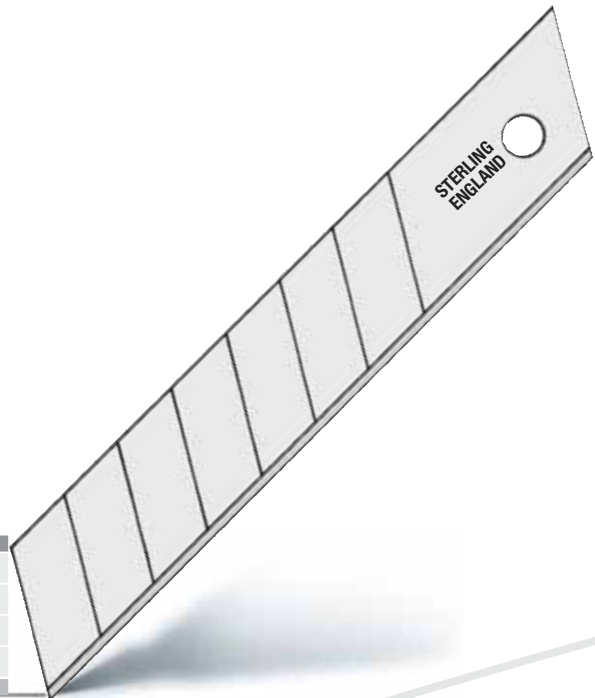
**1404-L****Large Snap Off Blade – 1404L**

- ▼ 8 point 18mm wide
- ▼ Made in PROC
- ▼ Suits all Large 18mm Snap Cutters. See pg. 12-17

CODE	DESCRIPTION	BOX QTY	CTN QTY
1404L-2	Tube of 50 - Taiwan	1	40
1404-L	Dispenser of 10 - Taiwan	10*	200
1404L-1	Card of 10 - Taiwan	10*	100
01005	Card of 5 - Taiwan	20*	200
* Box quantities only			
L 110mm W 18mm T 0.5mm			

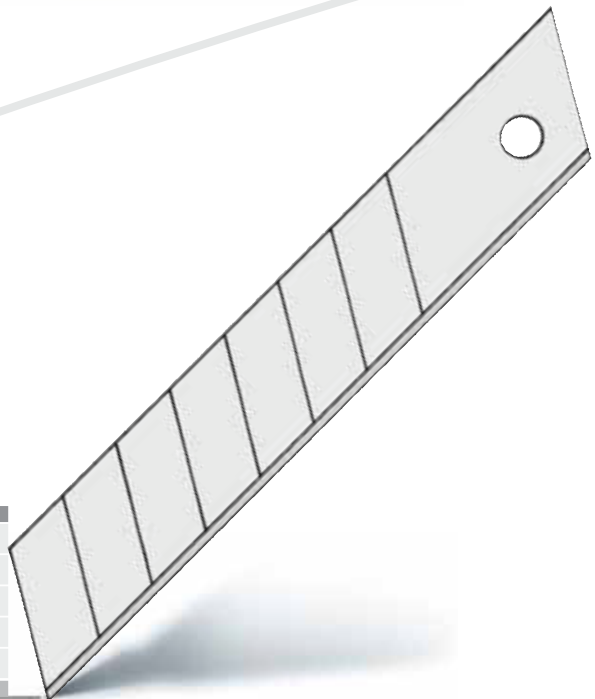
**203****Large Non Segmented Blade – 203**

- ▼ Non snap off 18mm wide
- ▼ Made in Sheffield - UK
- ▼ Suits all Large 18mm Snap Cutters. See pg. 12-17 & 23

CODE	DESCRIPTION	BOX QTY	CTN QTY
203-4	Tube of 10	10*	500
* Box quantities only			
L 110mm W 18mm T 0.5mm			

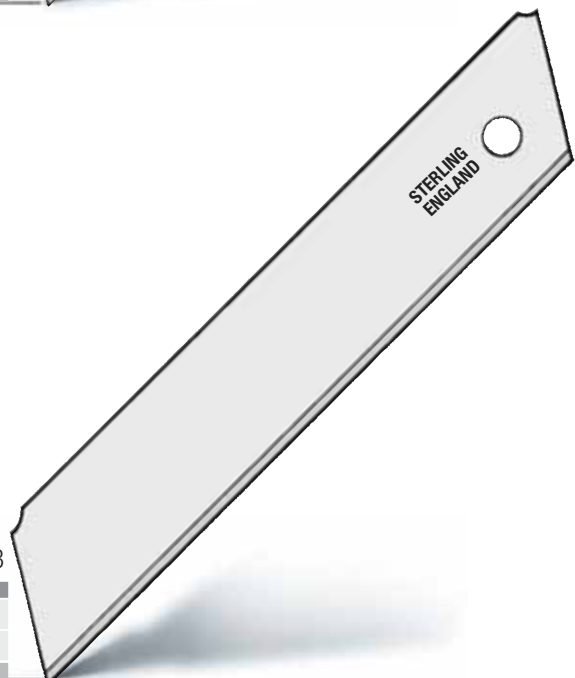



**1402-G**

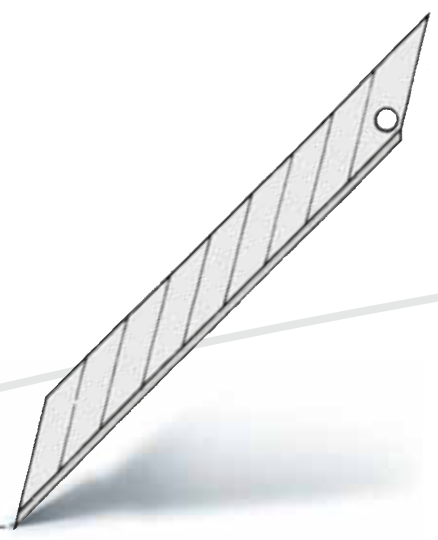

**Small Snap Off Blade – 1402**

- ▼ Sharp angled 9mm wide
- ▼ Suits most Small Snap Cutters. See pg. 19-21

CODE	DESCRIPTION	BOX QTY	CTN QTY
1402-G	Dispenser of 5 Made in Germany	1	10
1402-4	Tube of 10 Made in Taiwan	1	48
		L 87mm W 9mm T 0.38mm	

**200**

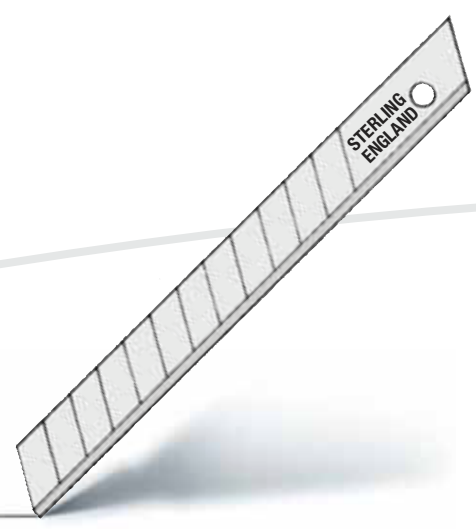

**Small Snap Off Blade – 200**

- ▼ 13 point 9mm
- ▼ Made in Sheffield UK
- ▼ Suits all Small Snap Cutters. See pg. 19-21

CODE	DESCRIPTION	BOX QTY	CTN QTY
200-2	Tube of 50 - Sheffield Carbon	1	-
200-4	Tube of 10 - Sheffield Carbon	10	100
200-1	Card of 10 - Sheffield Carbon	10	100
200-2S	Tube of 50 - Sheffield Stainless	1	200
200-4S	Tube of 10 - Sheffield Stainless	10	500
		L 87mm W 9mm T 0.38mm	

**1403-S**

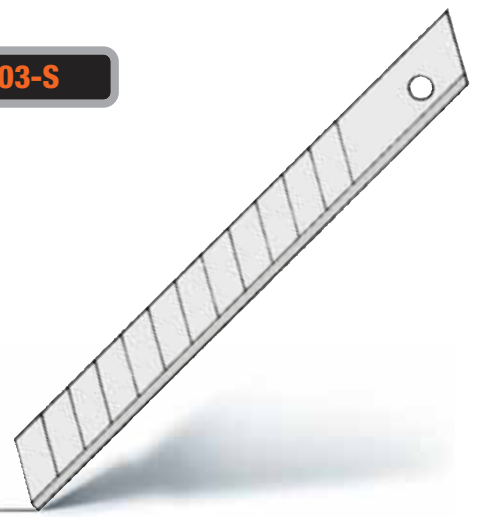

**Small Snap Off Blade**

- ▼ 13 point 9mm
- ▼ Made in PROC
- ▼ Suits all Small Snap Cutters. See pg. 19-21

CODE	DESCRIPTION	BOX QTY	CTN QTY
1403-S	Tube of 10	10	500
02005	Card of 5	20	300
		L 87mm W 9mm T 0.38mm	

**202**



**Small Non Segmented Blade – 202**

- ▼ Non snap off 9mm wide
- ▼ Made in Sheffield - UK
- ▼ Suits all Small Snap Cutters. See pg. 19-21

CODE	DESCRIPTION	BOX QTY	CTN QTY
202-4	Tube of 10	10*	800
		* Box quantities only	
		L 85mm W 9mm T 0.40mm	

## 01-101

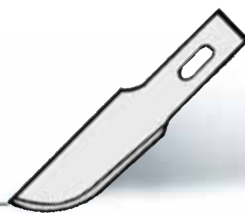
**No.10 Craft Blade**

▼ Made in USA

▼ Suits 50001, 50003 art knives. See pg. 28

CODE	DESCRIPTION	BOX QTY	CTN QTY
01-101-2	Box of 100	1	10
01-103-1	Card of 5	20	-
		L 37mm	W 8.5mm T 0.53mm

## 01-111

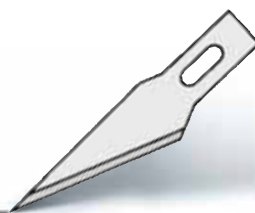
**No.11 Craft Blade**

▼ Made in USA

▼ Suits 50001, 50003 art knives. See pg. 28

CODE	DESCRIPTION	BOX QTY	CTN QTY
01-111-2	Box of 100	1	10
111-1	Card of 5	20	-
		L 39mm	W 8.5mm T 0.53mm

## 01-201-2

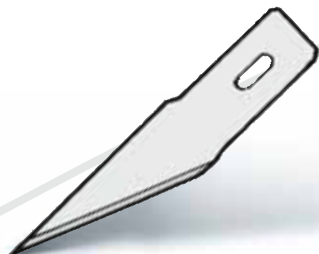
**No.2 Craft Blade**

▼ Made in USA

▼ Suits 50002, 50005 art knives. See pg. 28-29

CODE	DESCRIPTION	BOX QTY	CTN QTY
01-201-2	Plastic Box of 100	1	-
		L 47mm	W 10mm T 0.64mm

## 01-231-2

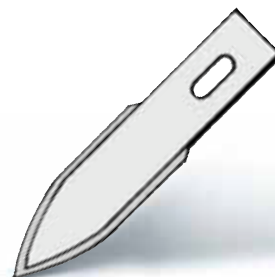
**No.23 Craft Blade**

▼ Made in USA

▼ Suits 50002, 50005 art knives. See pg. 28-29

CODE	DESCRIPTION	BOX QTY	CTN QTY
01-231-2	Box of 100	1	-
01-231TNC	TiN Coated each	1	100
		L 46.2mm	W 10.0mm T 0.64mm

01-161

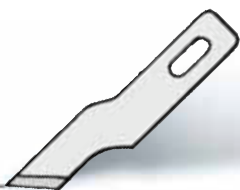
**No.16 Craft Blade**

- ▼ Made in USA
- ▼ Suits 50001, 50003 art knives. See pg. 28

CODE	DESCRIPTION	BOX QTY	CTN QTY
01-161-2	Box of 100	1	10
01-163-1	Card of 5	20	-
L 35mm W 7.8mm T 0.53mm			

1241

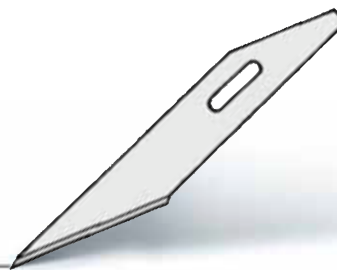
**No.1 Craft Tool Blade**

- ▼ Made in Sheffield - UK
- ▼ Suits Craft Tool No. 1231. See pg. 28

CODE	DESCRIPTION	BOX QTY	CTN QTY
1241	Box of 50	1	-
L 55mm W 8mm T 0.4mm			

01-173

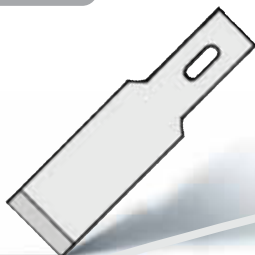
**No.17 Craft Blade**

- ▼ Made in USA
- ▼ Suits 50001, 50003 art knives. See pg.28

CODE	DESCRIPTION	BOX QTY	CTN QTY
01-173-1	Card of 5	1	10
L 38mm W 8.9mm T 0.53mm			

1242

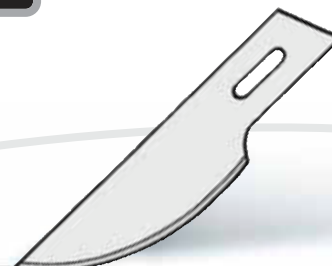
**No.2 Craft Tool Blade**

- ▼ Made in Sheffield - UK
- ▼ Suits Craft Tool No. 1231. See pg. 28

CODE	DESCRIPTION	BOX QTY	CTN QTY
1242	Box of 50	1	-
L 51mm W 12mm T 0.4mm			

01-181

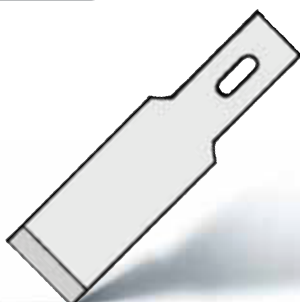
**No.18 Craft Blade**

- ▼ Made in USA
- ▼ Suits 50002, 50005 art knives. See pg. 28-29

CODE	DESCRIPTION	BOX QTY	CTN QTY
01-181-2	Box of 100	1	-
L 45mm W 12.8mm T 0.65mm			

1243

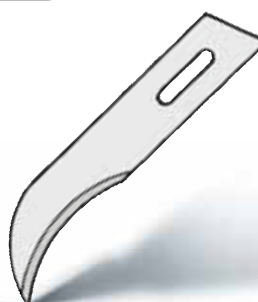
**No.3 Craft Tool Blade**

- ▼ Made in Sheffield - UK
- ▼ Suits Craft Tool No. 1231. See pg. 28

CODE	DESCRIPTION	BOX QTY	CTN QTY
1243	Box of 50	1	-
L 46mm W 8mm T 0.4mm			

**33710****Small Round Router Blade**

▼ Made in USA

▼ Suits 50002, 50005 art knives. See pg. 28-29

CODE	DESCRIPTION	BOX QTY	CTN QTY
33710	Card of 2	1	-

**33720****Carving V Router Blade**

▼ Made in USA

▼ Suits 50002, 50005 art knives. See pg. 28-29

CODE	DESCRIPTION	BOX QTY	CTN QTY
33720	Card of 2	1	-

**33730****Large Round Router Blade**

▼ Made in USA

▼ Suits 50002, 50005 art knives. See pg. 28-29

CODE	DESCRIPTION	BOX QTY	CTN QTY
33730	Card of 2	1	-

**33740****Flat Rectangular Router Blade**

▼ Made in USA

▼ Suits 50002, 50005 art knives. See pg. 28-29

CODE	DESCRIPTION	BOX QTY	CTN QTY
33740	Card of 2	1	-

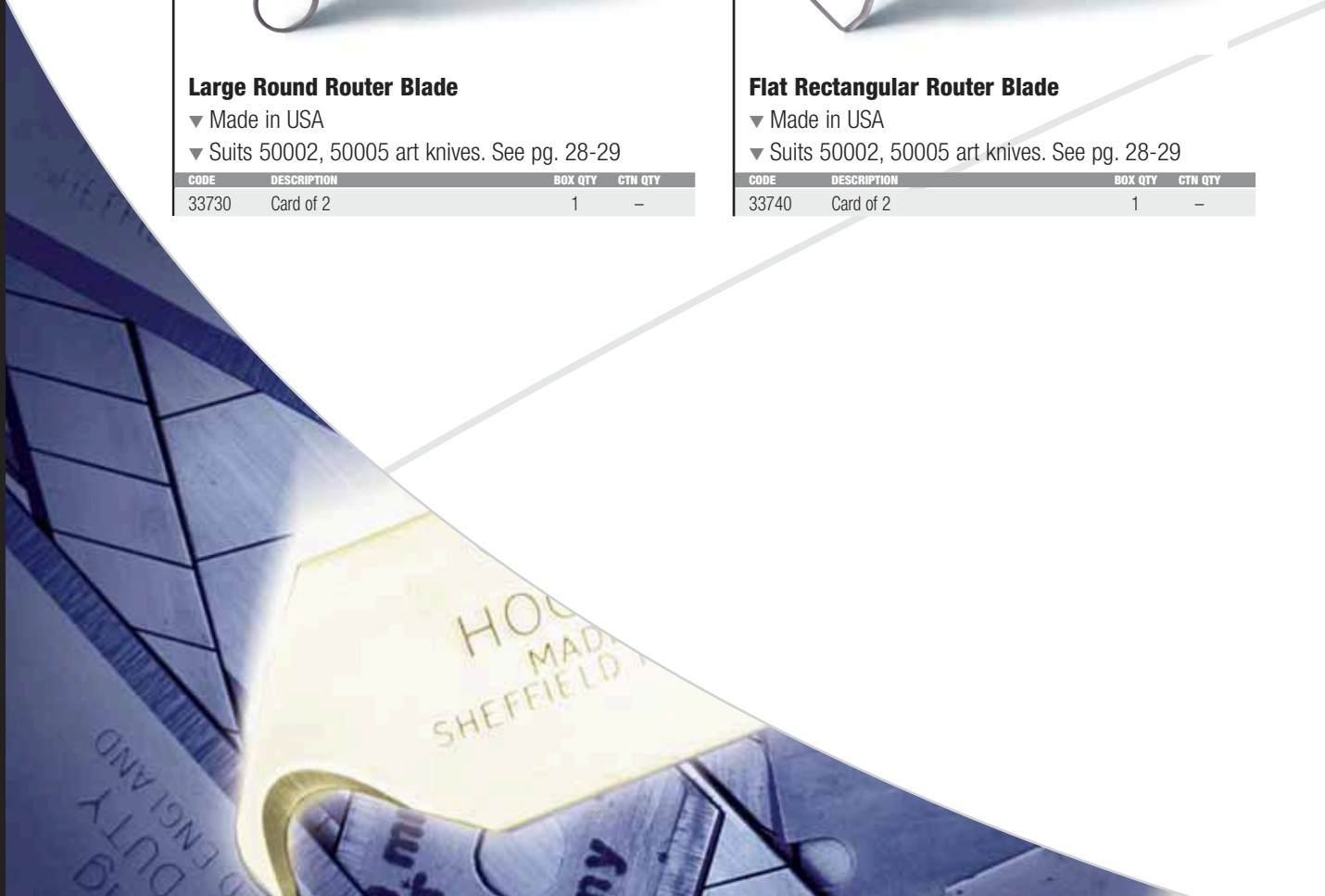

**SB-06**



**Skip Blade**

- ▼ Card of 2 blades
- ▼ 28mm diameter
- ▼ Suits RC-02. See pg. 30
- ▼ SKS-7 Tungsten Alloy Steel

CODE	DESCRIPTION	BOX QTY	CTN QTY
SB-06	Card of 2	2	60
ø 28mm T 0.3mm			

**RB-03**

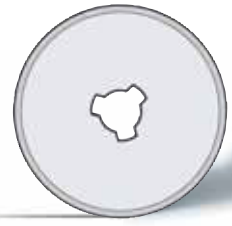

**Rotary Cutter Blade**

- ▼ 28mm diameter
- ▼ Suits RC-02. See pg. 30
- ▼ SKS-7 Tungsten Alloy Steel

CODE	DESCRIPTION	BOX QTY	CTN QTY
RB-03	Card of 2	1	60
ø 28mm T 0.3mm			

**RB-01**

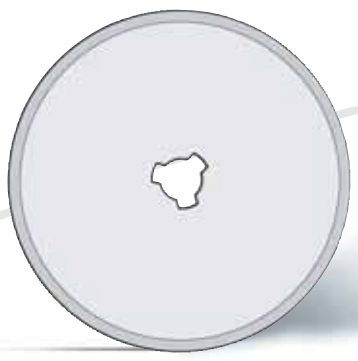

**Rotary Cutter Blade**

- ▼ 45mm diameter
- ▼ Suits RC-12 and RC11930. See pg. 30
- ▼ SKS-7 Tungsten Alloy Steel

CODE	DESCRIPTION	BOX QTY	CTN QTY
RB-01	Card of 1	1	60
RB-01-2	Bulk	50*	-
* Box quantities only			
ø 45mm T 0.3mm			

**RB-60**

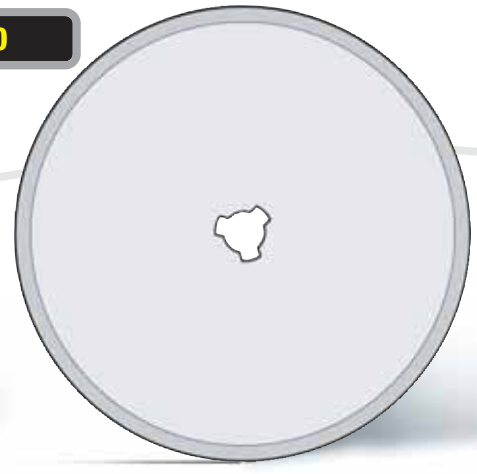

**Rotary Cutter Blade**

- ▼ 60mm diameter
- ▼ SKS-7 Tungsten Alloy Steel

CODE	DESCRIPTION	BOX QTY	CTN QTY
RB-60	Card of 1	1	-
ø 60mm T 0.4mm			

**1200D**

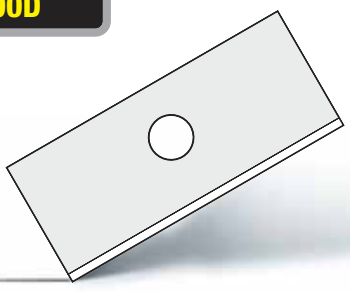

**Mat Cutter Blade – .012**

- ▼ Made in Sheffield - UK

CODE	DESCRIPTION	BOX QTY	CTN QTY
1200D	Pack of 5 Double Bevel	20*	2000
1200S	Pack of 5 Single Bevel	20*	2000
* Box quantities only			
L 44.6mm W 18.8mm T 0.3mm			

**1500D**

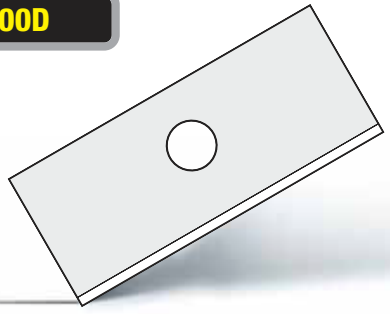

**Mat Cutter Blade – .015**

- ▼ Made in Sheffield - UK

CODE	DESCRIPTION	BOX QTY	CTN QTY
1500D	Pack of 5 Double Bevel	20*	2000
1500S	Pack of 5 Single Bevel	20*	2000
* Box quantities only			
L 44.6mm W 18.8mm T 0.38mm			



**420-4**

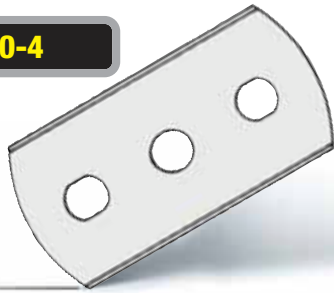

**Technical Blade – Round Cornered**

- ▼ Three hole, round cornered
- ▼ Made in Germany
- ▼ Long Life TiN Coatings available

CODE	DESCRIPTION	BOX QTY	CTN QTY
40-010	Box of 100 Light Duty 0.1mm	1	–
40-010TNC	TiN Coated each - Gold	1	–
420-4	Pack of 10 Heavy Duty 0.4mm	10*	–
420TNC	TiN Coated each - Gold	1	–

\* Box quantities only

W 43.5mm W 22mm

**80-020**



**Technical Blade – Square Cornered**

- ▼ Three hole, square cornered
- ▼ Made in Germany
- ▼ Long Life TiN Coatings available

CODE	DESCRIPTION	BOX QTY	CTN QTY
80-020	Box of 100 Light Duty 0.2mm	1	–
80-010TNC	TiN Coated 0.1mm - gold	1	–
80-015TNC	TiN Coated 0.15mm - gold	1	–
80-040	Box of 100 Heavy Duty 0.4mm	1	–

L 43.5mm W 22mm

**40-101**

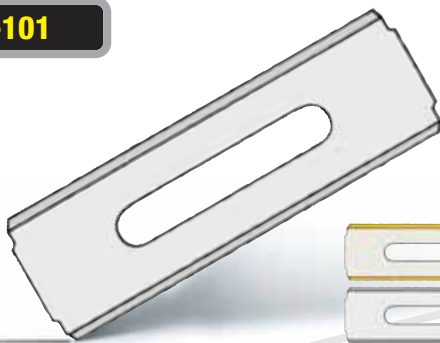

**Slotted Blade – Round Cornered**

- ▼ Round cornered
- ▼ Made in USA
- ▼ Long Life TiN & TiCN Coatings available

CODE	DESCRIPTION	BOX QTY	CTN QTY
40-101-2	Box of 100	1	50
40-101-4	Pack of 10	10*	–
40-101C	Cryo Treated Box of 100	1	–
40-101TNC	TiN Coated each - Gold	1	200
40-101TCN	TiCN Coated each - Grey	1	200

\* Box quantities only

L 57.3mm W 19mm T 0.38-0.43mm

**40-150**

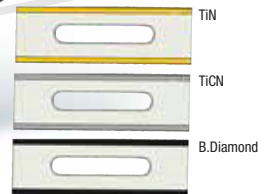
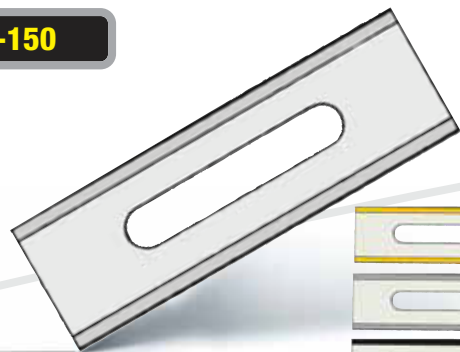

**Slotted Blade – Square Cornered**

- ▼ Square cornered
- ▼ Made in USA
- ▼ Long Life TiN, TiCN & Black Diamond Coatings available

CODE	DESCRIPTION	BOX QTY	CTN QTY
40-150-2	Box of 100	1	50
40-150C	Cryo Treated Box of 100	1	–
40-150TNC	TiN Coated each - Gold	1	200
40-150-4TNC	TiN Coated Dispenser of 10	1	–
40-150TCN	TiCN Coated each - Grey	1	200
40-150BD	Black Diamond Coated each-Black	1	200

L 57.3mm W 19mm T 0.38mm

**451-040R**

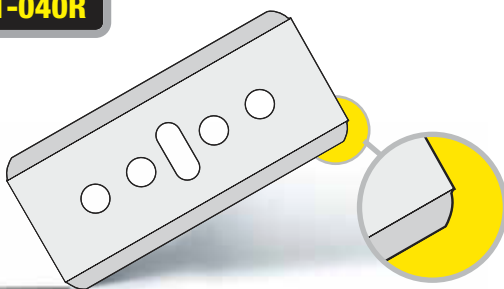

**Mica Knife Blade – Round Corners**

- ▼ Suits #100R Safety Mica Knife. See pg. 23

CODE	DESCRIPTION	BOX QTY	CTN QTY
451-040R	Tube of 10	1	50

L 39mm W 18.2mm T 0.40mm

**451-040**

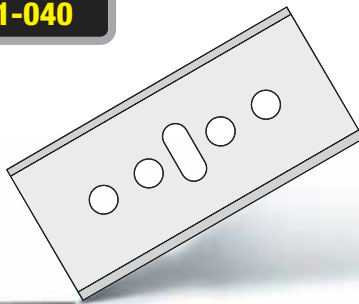

**Mica Knife Blade – Square Corners**

- ▼ Suits #100R Safety Mica Knife. See pg. 23

CODE	DESCRIPTION	BOX QTY	CTN QTY
451-040	Tube of 10	1	50

L 39mm W 18.2mm T 0.40mm

**471-040R**

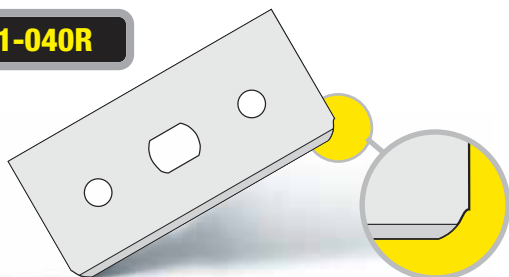

**Carton Blade – Round Corners**

▼ Fits #100B Brass Carton Cutter. See pg. 23

CODE	DESCRIPTION	BOX QTY	CTN QTY
471-040R	Tube of 10	1	50
		L 39mm	W 18.2m T 0.4mm

**60.20G**

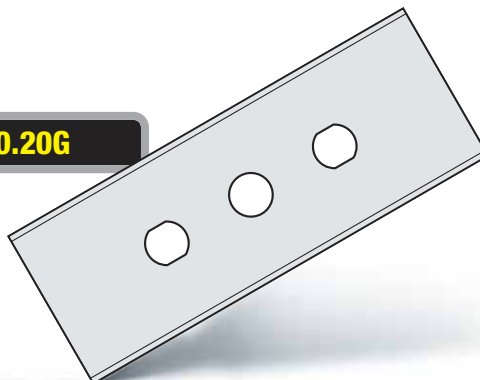

**60mm Technical Blade**

▼ 3 hole, square cornered

▼ Made in Germany

CODE	DESCRIPTION	BOX QTY	CTN QTY
60.20G	Bulk	200	1000
		L 60mm	W 22mm T 0.2mm

**40-500-4**

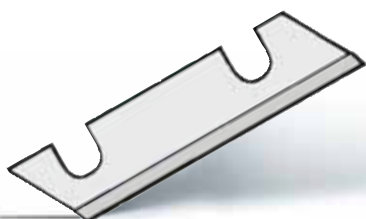

**Crain Type Strip Cutter Blade**

▼ Made in Sheffield - UK

CODE	DESCRIPTION	BOX QTY	CTN QTY
40-500-4	Pack of 10	1	-
		L 47mm	W 11.5mm T 1.0mm

**77-1506-4**

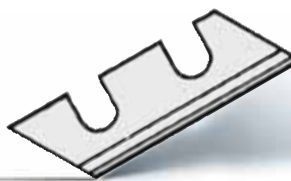

**Roberts Type Strip Cutter Blade**

▼ Made in USA

CODE	DESCRIPTION	BOX QTY	CTN QTY
77-1506-4	Pack of 8	1	-
		L 37.3mm	W 11.5mm T 1.0mm

**70-225-2**



**Fibreglass Chopper Blade**

▼ 0.875" x 0.312"

▼ Made in USA

▼ Suits Robinson, Glasscraft & other Chopper Guns

CODE	DESCRIPTION	BOX QTY	CTN QTY
70-225-2	Plastic Box of 100	1	10
		L 22mm	W 8mm T 0.25mm

**70-201-2**



**Fibreglass Chopper Blade**

▼ 1.00" x 0.312"

▼ Made in USA

▼ Suits most Venus, Binks & other Chopper Guns

CODE	DESCRIPTION	BOX QTY	CTN QTY
70-201-2	Plastic Box of 100	1	10
		L 25.5mm	W 8mm T 0.25mm

**70-1102**

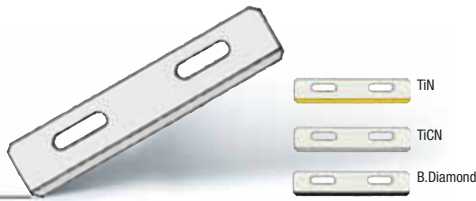

**Injector Blade**

- ▼ Stainless steel
- ▼ Made in USA
- ▼ Long Life TiN, TiCN & Black Diamond Coatings available
- ▼ Also suits some Venus fibreglass Chopper Guns

CODE	DESCRIPTION	BOX QTY	CTN QTY
70-1102-2	Box of 1000	1	-
70-1102-3	Dispenser of 20	1	-
70-1102TNC	TiN Coated each - Gold	1	200
70-1102TCN	TiCN Coated each - Grey	1	200
70-1102BD	Black Diamond Coated - Black	1	200

L 38mm W 8mm T 0.25mm

**10-750-2**

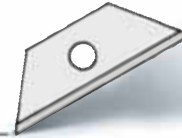

**Mini Blade**

- ▼ One hole
- ▼ Suits #110 - Mini Knife
- ▼ Made in Sheffield - UK

CODE	DESCRIPTION	BOX QTY	CTN QTY
10-750-2	Bulk 100	1	-
750-1	Card of 5	20*	-

\* Box quantities only

L 27.2mm W 9.2mm T 0.45mm

**404**

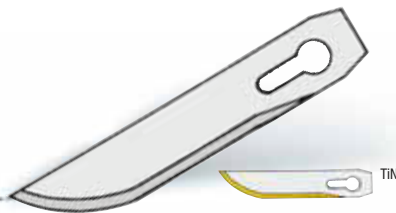

**Keyhole Blade – Convex**

- ▼ Made in Sheffield - UK

CODE	DESCRIPTION	BOX QTY	CTN QTY
404-2	Box of 50	1	-
404-1	Card of 3	20*	-
404TNC	TiN Coated each	1	50

\* Box quantities only

L 50.1mm W 9mm T 0.63mm

**401**

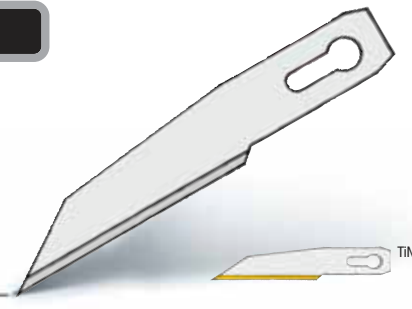

**Keyhole Blade – Straight Edge**

- ▼ Made in Sheffield - UK

CODE	DESCRIPTION	BOX QTY	CTN QTY
401-2	Box of 100	1	-
401-1	Card of 3	20*	-
401TNC	TiN Coated each	1	100

\* Box quantities only

L 58.5mm W 10.9mm T 0.63mm

**405**

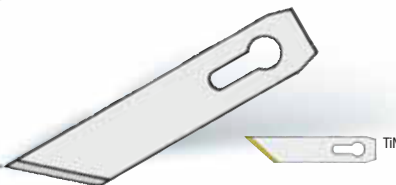

**Keyhole Blade – Short Angle**

- ▼ Made in Sheffield - UK

CODE	DESCRIPTION	BOX QTY	CTN QTY
405-2	Box of 100	1	-
405-1	Card of 3	20*	-
405TNC	TiN Coated each	1	100

\* Box quantities only

L 43.8mm W 9mm T 0.63mm

**406**

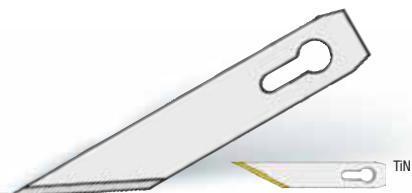

**Keyhole Blade – Long Angle**

- ▼ Made in Sheffield - UK

CODE	DESCRIPTION	BOX QTY	CTN QTY
406-2	Box of 100	1	-
406-1	Card of 3	20*	-
406TNC	TiN Coated each	1	100

\* Box quantities only

L 52.7mm W 9mm T 0.63mm

**301-020**

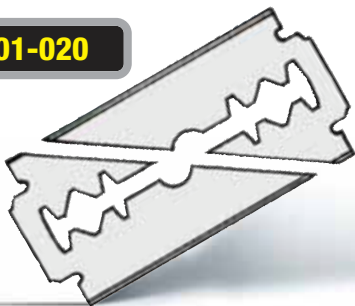

**Furriers Blade**

▼ 1/2 blades to suit Furrier's knife. See pg. 36

CODE	DESCRIPTION	BOX QTY	CTN QTY
301-020	Bulk 200x1/2 Blades Germany	1	-
301-020A	Bulk 200x1/2 Blades Sweden	1	-
L 43mm W 22mm T 0.1mm			

**04**

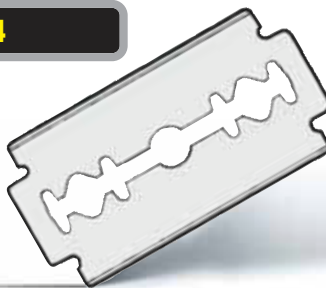

**Shaving Blade**

▼ Stainless steel, double sided  
▼ Made in Sheffield - UK

CODE	DESCRIPTION	BOX QTY	CTN QTY
04	Pack of 5	20*	1000
L 43mm W 22mm T 0.1mm			

**04-031**

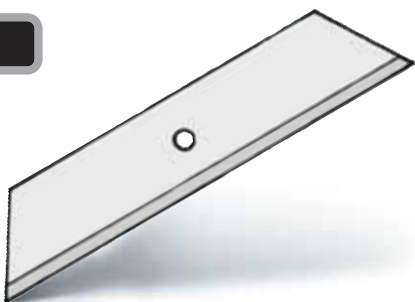

**Poultry Blade**

▼ Available in Stainless Steel\* or Carbon Steel\*\*

CODE	DESCRIPTION	BOX QTY	CTN QTY
04-031	Box of 400 Stainless Steel USA*	1	-
SM-90	Box of 100 Carbon Steel UK**	1	-
L 61mm W 12.6mm T 0.65mm			

**3088B**

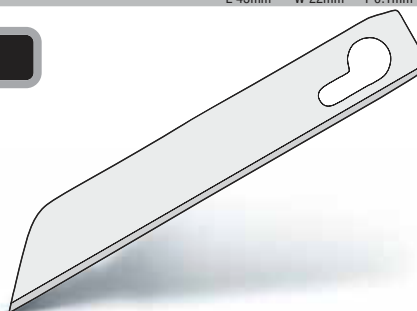

**Pocket Knife Blade**

▼ Stainless steel to suit 3088 pocket knife. See pg. 35

CODE	DESCRIPTION	BOX QTY	CTN QTY
3088B	Card of 1	1	12
L 65.2mm W 10.2mm T 1.0mm			

**8237**



**Perforator Blade**

▼ Made in Germany

CODE	DESCRIPTION	BOX QTY	CTN QTY
8237	Each Bulk	1	-
L 33.4mm W 10mm T 0.2mm			

**B-39**

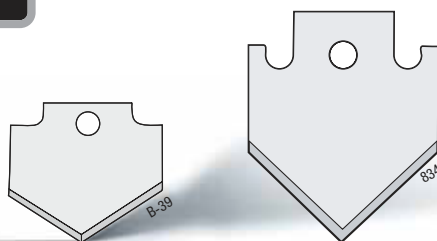

**Arrow Head Blade**

▼ B-39 suits TC-11 tube cutter. See pg. 36

CODE	DESCRIPTION	BOX QTY	CTN QTY
B-39	Tube of 10 Made in Taiwan	1	-
L 17.7mm W 19.3mm T 0.4mm			
8340	Pack of 10 Made in Germany	1	-
L 30.6mm W 24.85mm T 0.5mm			

**13-2202**

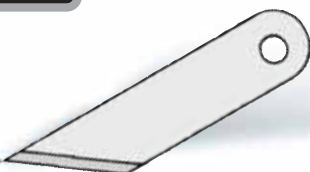

**Dexter Blade**

▼ Suits a Dexter knife in a C&H machine  
▼ Made in USA

CODE	DESCRIPTION	BOX QTY	CTN QTY
13-2202-2	Box of 100		
2202-1	Card of 5	20*	
* Box quantities only			
L 44mm W 9mm T 0.63mm			

**407-3**

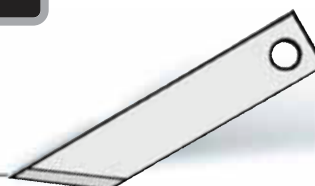

**Laila Craft Blade**

▼ Made in USA

CODE	DESCRIPTION	BOX QTY	CTN QTY
407-3	Pack of 5	20*	
* Box quantities only			
L 44.2mm W 9.1mm T 0.64mm			

**50-151-4****Scraper Blade - 4"**

- ▼ 100mm (4") Single Edge Scraper Blade
- ▼ Suits scrapers No. TH6230, 14-010, 14-012, 14-030, 14-048 plus most 4" scrapers. See pg. 44

CODE	DESCRIPTION	BOX QTY	CTN QTY
50-151-4	Tube of 10 Made in USA	10	200
50-153-2	Box of 100 Made in USA	1	30
6231	Card of 2 Made in Taiwan	1	-
		L 102mm	W 14mm T 0.52mm

**50-089-4****Scraper Blade - 5"**

- ▼ 125mm (5") Single Edge Scraper Blade
- ▼ Suits No. 14-088 5" Scraper. See pg. 44

CODE	DESCRIPTION	BOX QTY	CTN QTY
50-089-4	Tube of 10	1	20
		L 125mm	W 19mm T 0.9mm

**50-085-4****Scraper Blade - 6"**

- ▼ 148mm (6") Single Edge Scraper Blade
- ▼ Suits No. 14-084 6" Scraper. See pg. 45

CODE	DESCRIPTION	BOX QTY	CTN QTY
50-085-4	Pack of 10	1	-
		L 148mm	W 24mm T 0.68mm



6234

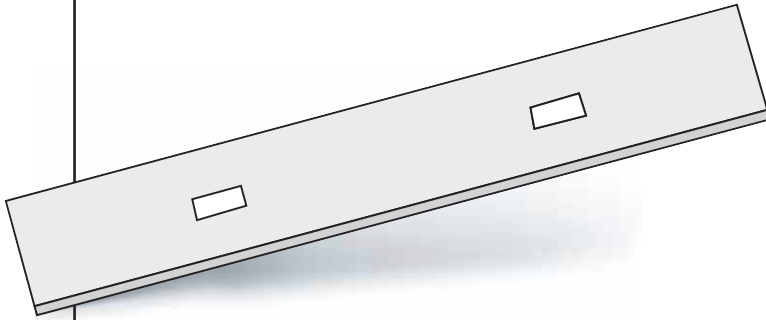

**Scraper Blade – 4”**

- ▼ 100mm (4”) Single Edge Scraper Blade
- ▼ Suits code No. 1910 4” Window Scraper. See pg. 42

CODE	DESCRIPTION	BOX QTY	CTN QTY
6234	Dispenser of 10 Carded	10	500
L 102mm W 17.4mm T 0.50mm			



For a full range of scrapers, see pages 40-45

811004

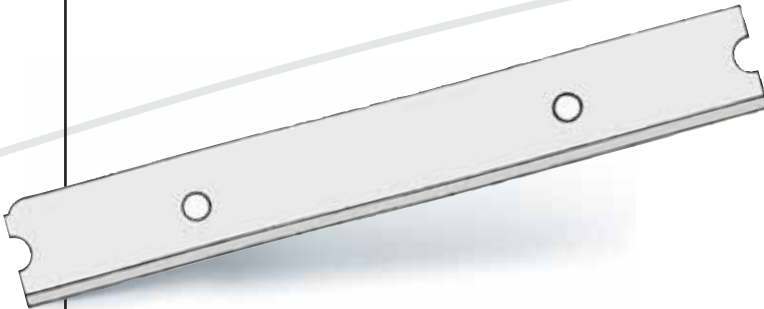

**Scraper Blade – 4” Single Sided**

- ▼ Made in Germany
- ▼ 100mm (4”) Single Edge Scraper Blade suits Ettore Quick Guard, Ettore Super Scraper, Unger Window Scraper, Eureka Metal Scraper and other 4” Scrapers

CODE	DESCRIPTION	BOX QTY	CTN QTY
811004	Pack of 10	1	–
775-040	Box of 100	1	10
L 100mm W 14mm T 0.4mm			

40-201-4

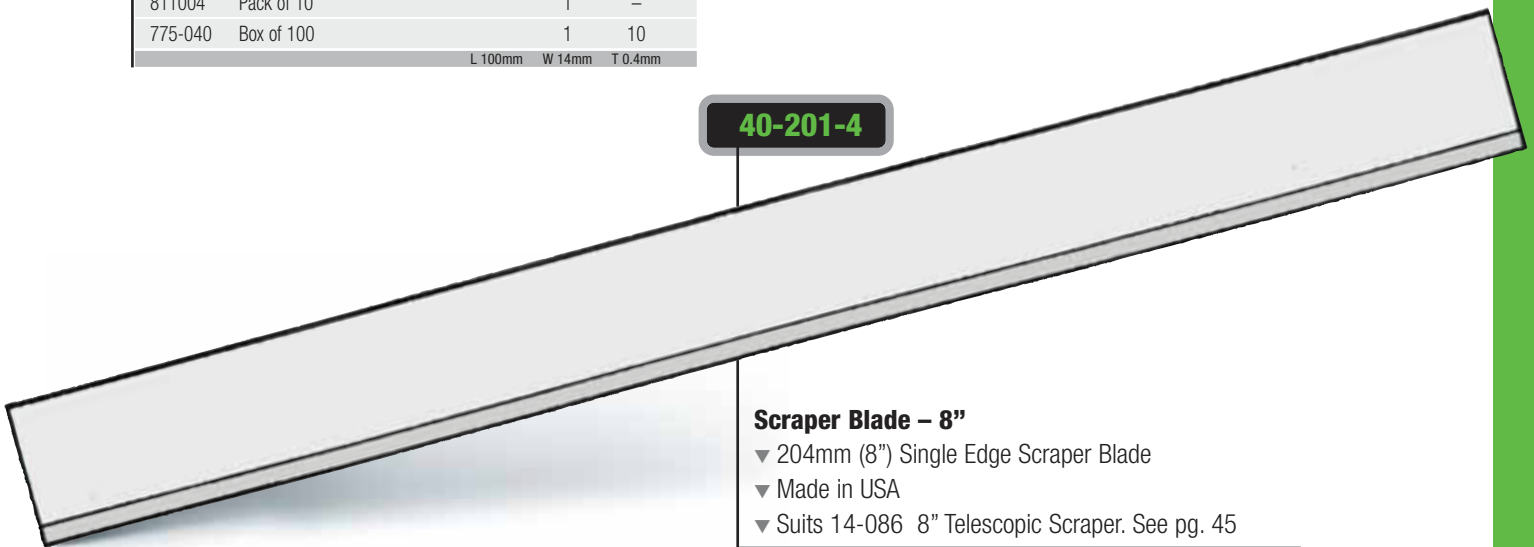

**Scraper Blade – 8”**

- ▼ 204mm (8”) Single Edge Scraper Blade
- ▼ Made in USA
- ▼ Suits 14-086 8” Telescopic Scraper. See pg. 45

CODE	DESCRIPTION	BOX QTY	CTN QTY
40-201-4	Tube of 10	1	10
L 204mm W 19mm T 0.9mm			

820943

**Scraper Blade – 94mm Double Sided**

- ▼ Made in Germany
- ▼ Suits No. HDSCR Black Scraper. See pg. 42

CODE	DESCRIPTION	BOX QTY	CTN QTY
820943	Pack of 10	1	–
894-030	Pack of 25	1	–
		L 94mm	W 22mm T 0.3mm

820402

**Scraper Blade – 40mm Double Sided**

- ▼ Suits Snappy Scraper
- ▼ Made in Germany

CODE	DESCRIPTION	BOX QTY	CTN QTY
820402	Pack of 10	1	–
		L 40mm	W 22mm T 0.2mm

821252

**Scraper Blade – 5" Double Sided**

- ▼ 125mm 5" Double Sided Blade
- ▼ Made in Germany
- ▼ Suits No. 1918 Champion Scraper. See pg. 43

CODE	DESCRIPTION	BOX QTY	CTN QTY
821252	Pack of 10	1	–
		L 125mm	W 22mm T 0.2mm

820802

**Scraper Blade – 80mm Double Sided**

- ▼ Made in Germany
- ▼ Suits No. 1919 Handy Scraper. See pg.42

CODE	DESCRIPTION	BOX QTY	CTN QTY
820802	Pack of 10	1	–
852-020	Pack of 25	1	–
		L 80mm	W 22mm T 0.2mm

821502

**Scraper Blade – 6" Double Sided**

- ▼ 152mm 6" Double Sided Blade
- ▼ Made in Germany
- ▼ Suits No. 1917 Triumph Mk2 Scraper. See pg. 43

CODE	DESCRIPTION	BOX QTY	CTN QTY
821502	Pack of 10	1	–
854-020	Pack of 25	1	–
854-020B	Box of 200	1	–
		L 152mm	W 22mm T 0.2mm

821002

**Scraper Blade – 4" Double Sided**

- ▼ 100mm 4" Double Sided Blade
- ▼ Made in Germany
- ▼ Suits Unger Trim Scraper

CODE	DESCRIPTION	BOX QTY	CTN QTY
821002	Pack of 10 (0.2mm thick)	1	–
		L 100mm	W 22mm T 0.2mm

blades - scraping

**300-18**



**Hacksaw Blades**

- ▼ Bi-Metal Flexible Blade 12" / 300mm
- ▼ Industrial Quality
- ▼ Suits No. HF-329 Hacksaw Frame. See pg. 34

CODE	DESCRIPTION	PACK QTY	BOX QTY
300-18	18TPI	10*	100
300-24	24TPI	10*	100
300-32	32TPI	10*	100

\* Pack quantities only

**Hacksaw Frame:  
see page 34**

**CBB-18**



**Air Hack-Saw Blades**

- ▼ Car Body Blades
- ▼ Bi-Metal
- ▼ 18, 24, 32 TPI available

CODE	DESCRIPTION	BOX QTY	CTN QTY
CBB-18	Pack of 10 - Sandflex	1	
CBB-24	Pack of 10 - Sandflex	1	
CBB-32	Pack of 10 - Sandflex	1	
CBB-18A	Pack of 10 - Alpha	1	
CBB-24A	Pack of 10 - Alpha	1	
CBB-32A	Pack of 10 - Alpha	1	

**No.3 FITMENT BLADES**



For scalpel handles, see pg. 27

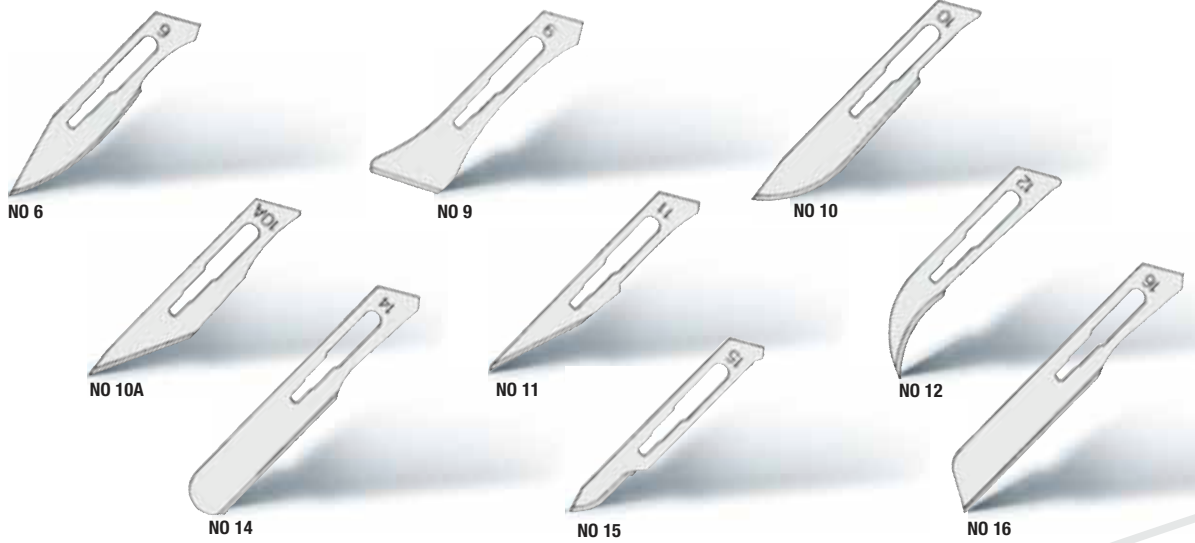

**Swann Morton Scalpel Blades**

- ▼ Made in Sheffield
- ▼ Sterile blades individually wrapped

CODE	DESCRIPTION	BOX QTY	CTN QTY
No. 6SM	Sterile – 100	1	–
No. 9SM	Sterile – 100	1	–
No. 10SM	Sterile – 100	1	–
No. 10ASM	Sterile – 100	1	–
No. 11SM	Sterile – 100	1	–
No. 12SM	Sterile – 100	1	–
No. 14SM	Sterile – 100	1	–
No. 15SM	Sterile – 100	1	–
No. 16SM	Sterile – 100	1	–

**Scalpel Blades**

- ▼ Sterile blades individually wrapped

CODE	DESCRIPTION	BOX QTY	CTN QTY
No. 6	Sterile – 100	1	–
No. 9	Sterile – 100	1	–
No. 10	Sterile – 100	1	–
No. 10A	Sterile – 100	1	–
No. 11	Sterile – 100	1	–
No. 12	Sterile – 100	1	–
No. 14	Sterile – 100	1	–
No. 15	Sterile – 100	1	–
No. 16	Sterile – 100	1	–



**Swann Morton Disposable Scalpels**

- ▼ Complete with blade and handle disposable unit
- ▼ Made in Sheffield

CODE	DESCRIPTION	BOX QTY	CTN QTY
No. 6DSM	Sterile – 10	1	–
No. 9DSM	Sterile – 10	1	–
No. 10DSM	Sterile – 10	1	–
No. 10ADSM	Sterile – 10	1	–
No. 11DSM	Sterile – 10	1	–
No. 12DSM	Sterile – 10	1	–
No. 14DSM	Sterile – 10	1	–
No. 15DSM	Sterile – 10	1	–
No. 16DSM	Sterile – 10	1	–

**Disposable Scalpels**

- ▼ Complete with blade and handle disposable unit

CODE	DESCRIPTION	BOX QTY	CTN QTY
No. 10D	Sterile – 10	1	–
No. 10AD	Sterile – 10	1	–
No. 11D	Sterile – 10	1	–
No. 12D	Sterile – 10	1	–
No. 15D	Sterile – 10	1	–

**No.4 FITMENT BLADES**

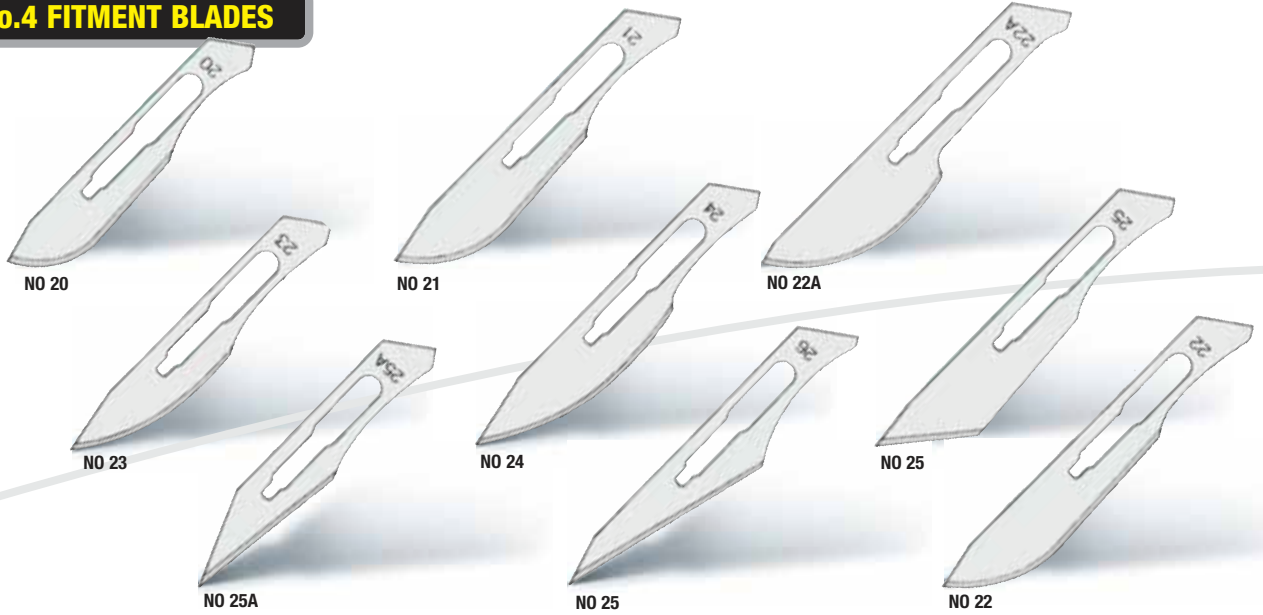

For scalpel handles, see pg. 27

**Swann Morton Scalpel Blades**

- ▼ Made in Sheffield
- ▼ Sterile blades individually wrapped

CODE	DESCRIPTION	BOX QTY	CTN QTY
No. 20SM	Sterile – 100	1	–
No. 21SM	Sterile – 100	1	–
No. 22SM	Sterile – 100	1	–
No. 22ASM	Sterile – 100	1	–
No. 23SM	Sterile – 100	1	–
No. 24SM	Sterile – 100	1	–
No. 25SM	Sterile – 100	1	–
No. 25ASM	Sterile – 100	1	–
No. 26SM	Sterile – 100	1	–

**Scalpel Blades**

- ▼ Sterile blades individually wrapped

CODE	DESCRIPTION	BOX QTY	CTN QTY
No. 20	Sterile – 100	1	–
No. 21	Sterile – 100	1	–
No. 22	Sterile – 100	1	–
No. 22A	Sterile – 100	1	–
No. 23	Sterile – 100	1	–
No. 24	Sterile – 100	1	–
No. 25	Sterile – 100	1	–
No. 25A	Sterile – 100	1	–
No. 26	Sterile – 100	1	–



**Swann Morton Disposable Scalpels**

- ▼ Complete with blade and handle disposable unit
- ▼ Made in Sheffield

CODE	DESCRIPTION	BOX QTY	CTN QTY
No. 20DSM	Sterile – 10	1	–
No. 21DSM	Sterile – 10	1	–
No. 22DSM	Sterile – 10	1	–
No. 22ADSM	Sterile – 10	1	–
No. 23DSM	Sterile – 10	1	–
No. 24DSM	Sterile – 10	1	–
No. 25DSM	Sterile – 10	1	–
No. 25ADSM	Sterile – 10	1	–
No. 26DSM	Sterile – 10	1	–

**Disposable Scalpels**

- ▼ Complete with blade and handle disposable unit
- ▼ Supplied with safety cap

CODE	DESCRIPTION	BOX QTY	CTN QTY
No. 20D	Sterile – 10	1	–
No. 21D	Sterile – 10	1	–
No. 22D	Sterile – 10	1	–
No. 22AD	Sterile – 10	1	–
No. 23D	Sterile – 10	1	–
No. 24D	Sterile – 10	1	–

blades - scalpel